



Edge Owner's Manual



WARNING: This airgun is recommended for adult use only. Careless use may result in serious injury or death. Dangerous within 510 yards (470 meters).

Read all instructions before using this rifle.

This airgun should only be used by responsible persons 18 years or older.

Use lead pellets only. Compressed air or dry nitrogen only.

Contents

Specifications	1
Warnings	2
Manufacturer's Contact Information	2
Nomenclature	3
1. Safety First	4
2. Operating the Cocking Handle	4
3. Pressurizing the Air Tank	7
4. Adjusting the Stock	8
5. Adjusting the Forearm	9
6. Adjusting the Trigger	9
7. Maintenance	10

Specifications

Velocity	Approximately 500 f.p.s.
Fill pressure	3,000 psi/ 206 bar (only use compressed air or dry nitrogen)
Weight	6.1 lbs.
Length	35-40 inches
Barrel	12 inches
Action	Single-shot
Caliber	.177 (4, 5mm)
Trigger	2-stage adjustable
Safety	Manual
Sights	Peep or optical may be installed
Length of pull	12-17 inches



WARNING: Always wear eye protection when using this airgun. This includes everyone in the area where shooting is taking place.



WARNING: Modifications to this rifle beyond user adjustments specifically outlined in this manual are not authorized. Any modification or tampering with the gun may cause malfunction and make the gun unsafe for use.



WARNING: Remove the air tank before making any adjustments, performing any maintenance or adding/removing any accessories.



WARNING: Because this airgun has an adjustable match grade trigger, it could fire when dropped or jarred.

For repairs contact the manufacturer. You will be given instructions how to return the rifle to the factory or other authorized repair station.

AirForce

P.O. Box 2478, Fort Worth, TX 76113
Tel 817-451-8966 Fax: 817-451-1613
staff@airforceairguns.com

Use of air with the rifle

This air rifle is designed for use with clean, dry compressed air or dry nitrogen only. The maximum fill pressure is 3,000 pounds per square inch (psi), which is 206 bar. A pressure relief device has been installed in the air tank and can rupture if the internal pressure exceeds 3,000 psi/206 bar.

The Edge has a precision rifled barrel. It will shoot accurately only with good quality, match grade lead pellets.

The use of any projectile other than a lead pellet is unauthorized and will void the warranty.

Nomenclature

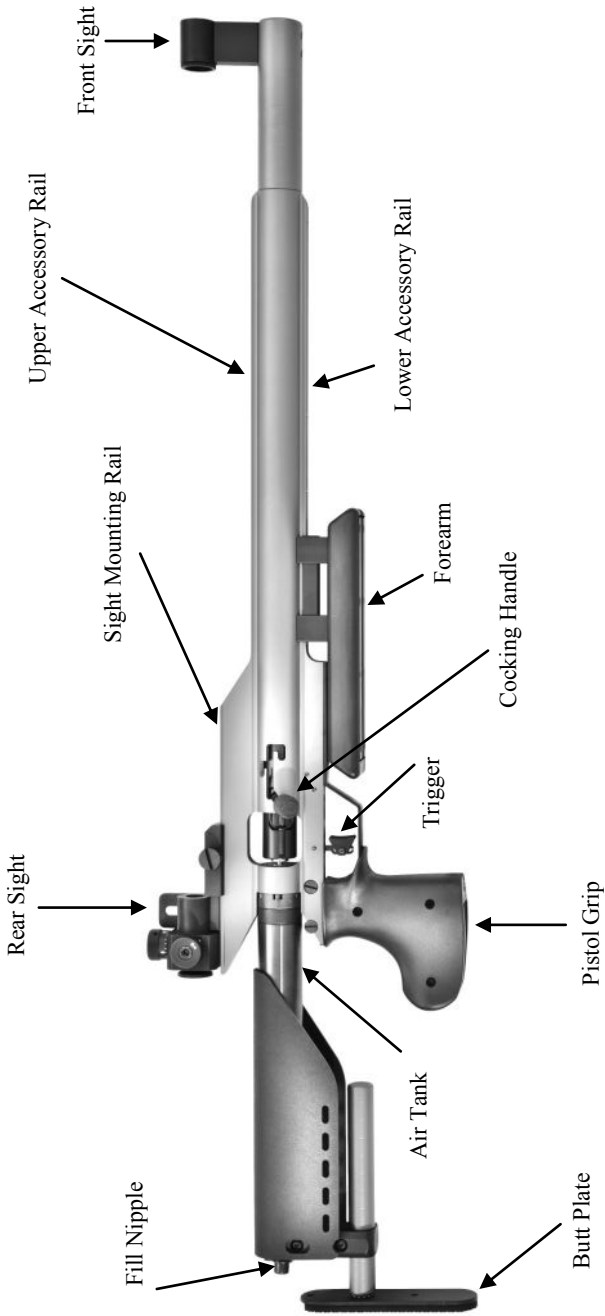

1. Safety First

Any gun is dangerous when handled improperly, including an air gun. Review the three safety rules that follow, plus the special warnings that appear throughout this manual.

1.1 Airgun safety

Airguns are unique because the gun provides the power for the shot—not the ammunition. NEVER put anything into the barrel of this airgun except high quality lead pellets.

1.2 Three important rules

1. Always point the muzzle in a direction that will not cause injury or property damage if the gun discharges.
2. Keep your finger off the trigger until you are ready to shoot.
3. Don't load the gun until you are ready to shoot.

2. Operating the Cocking Handle

The striker in the rifle must be in the cocked position to fire a pellet. This is achieved by pushing the cocking handle position all the way forward. (See Figure 1.) While the cocking handle is forward, the rear of the barrel is exposed and a pellet may be loaded if desired. When loading a pellet, be sure to push it in as far as it will go with your thumb or a pellet seater.

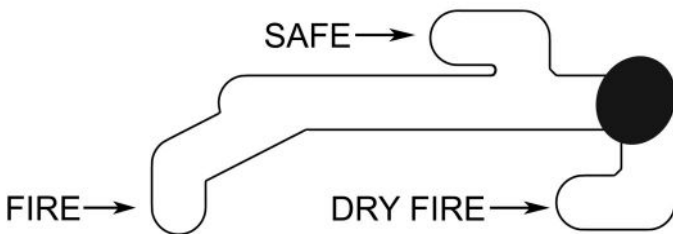

Figure 1.

To fire the pellet the cocking handle is placed in the FIRE position. (See Figure 2.)

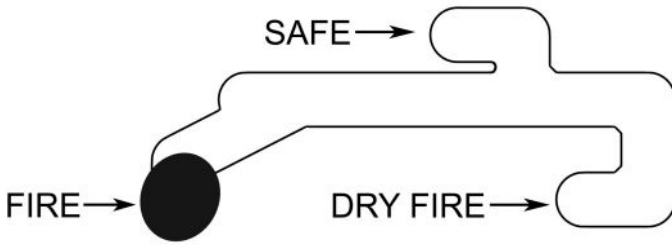

Figure 2.

⚠ CAUTION: If the striker is cocked and the trigger is pulled while the cocking handle is in the SAFE position, the striker will be released. The rifle will not fire. But if the striker is repeatedly released by the trigger while the cocking handle is in the SAFE position the rifle may be damaged.

2.1 Activating the Safety

The Safety is activated by putting the cocking handle into the SAFE position. This position blocks the striker inside the rifle from opening the valve in the air tank.

The striker should normally be un-cocked when the cocking handle is put in the SAFE position. To un-cock the striker push the cocking handle all the way forward and while holding the cocking handle securely, pull the trigger with your other hand and ease the cocking handle rearward and place it in the SAFE position (See Figure 3).

Always leave the rifle in the SAFE position unless you are ready to fire.

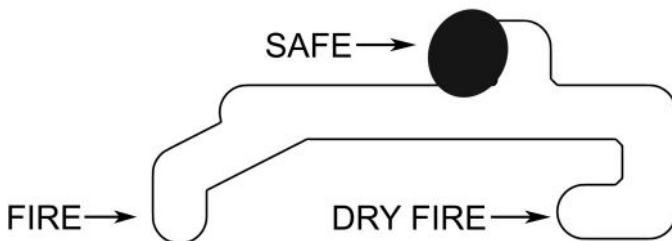

Figure 3.

2.2 Dry Firing

The DRY FIRE position is used for shooting practice.

(See Figure 4.)

No ammunition is used when practicing using the DRY FIRE position. Push the cocking handle all the way forward then down into the DRY FIRE position. After the trigger is pulled push the cocking handle all the way forward again to re-cock the striker.

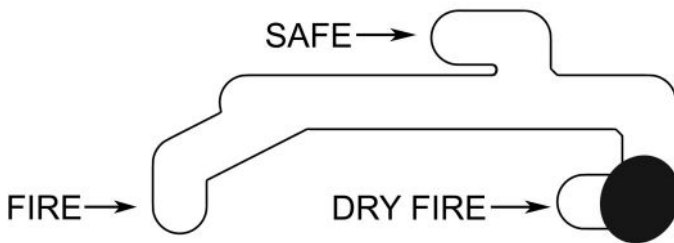



Figure 4.

2.3 Changing Cocking Knob Position for Left-Handed Shooters

The cocking knob may be moved to the left side of the rifle.

1. Remove the rubber cover and, using a coin, unscrew the cocking knob from its metal anchor.
2. Rotate the metal anchor to the opposite side of the rifle and line it up with the cocking slot.
3. Re-insert the cocking knob. Make sure the anchor still moves freely inside the retention o-ring.
4. A small drop of thread locking compound on the cocking knob thread will help secure it in place.

3. Pressurizing the Air Tank

 **WARNING:** Use only compressed air or dry nitrogen to fill the Air Tank provided with this rifle. Use of other gases including oxygen or acetylene can cause a fire or explosion causing serious injury or death.

- Always wear eye protection.
- Make sure the airgun is unloaded and the cocking handle is in the SAFE position (See Figure 3).
- The fill nipple protective cap should be removed.
- The fill nipple can connect to an AirForce fill station or to a fill device using a standard Fosters type 12FSS type quick disconnect or equivalent that is rated for 3000 psi or above.

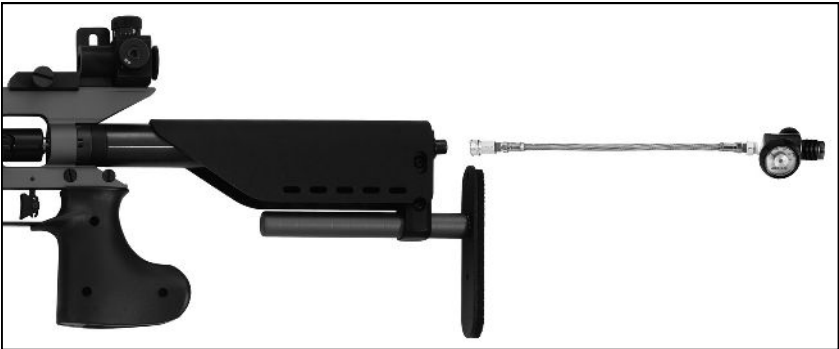

Figure 5.

- This airgun utilizes a regulator inside the air tank, only clean dry air is recommended for use. Maximum fill pressure is 3000 psi or 206 bar.
- The Air Tank may be pressurized while it is attached to the rifle or separately.
- The Air Tank may be stored while under pressure.

4. Adjusting the Stock

- Make sure the airgun is on SAFE. (See Figure 3.)
- The cheek piece may be raised a small amount by loosening the clamping screws as shown in Figure 6.

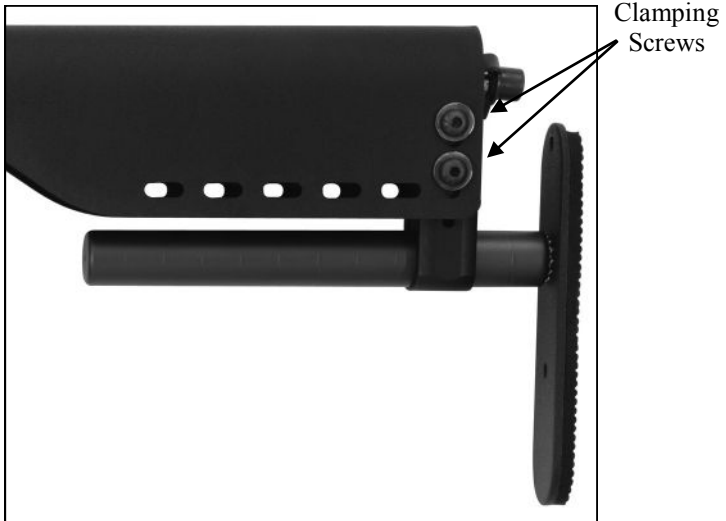

Figure 6.

The butt plate may be repositioned horizontally and adjusted for cant by loosening the clamping screws indicated in Figure 7.

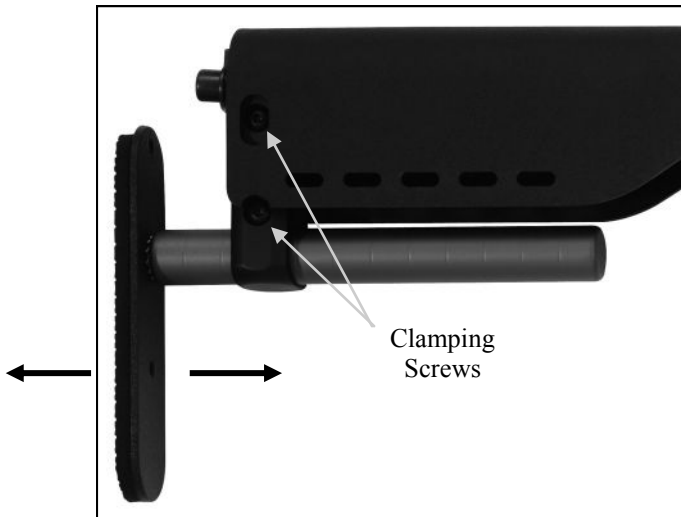

Figure 7.

5. Adjusting the Forearm

Make sure the airgun is on SAFE. The forearm may be repositioned anywhere along the Lower Accessory Rail by loosening the clamping screws. (See Figure 8.)

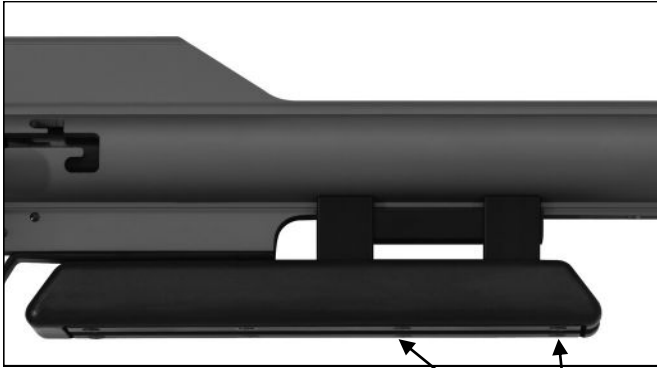

Figure 8.
Clamping Screws are located
Between forearm accessory rails.

6. Adjusting the Trigger

Make sure the airgun is on SAFE. The trigger may be adjusted for weight of pull with the adjustment screw shown in Figure 9 and by moving the trigger vertically in its adjustment slot.



Figure 9.

7. Maintenance

Apply a small amount of o-ring lubricant to the barrel as indicated in Figures 10 and 11.

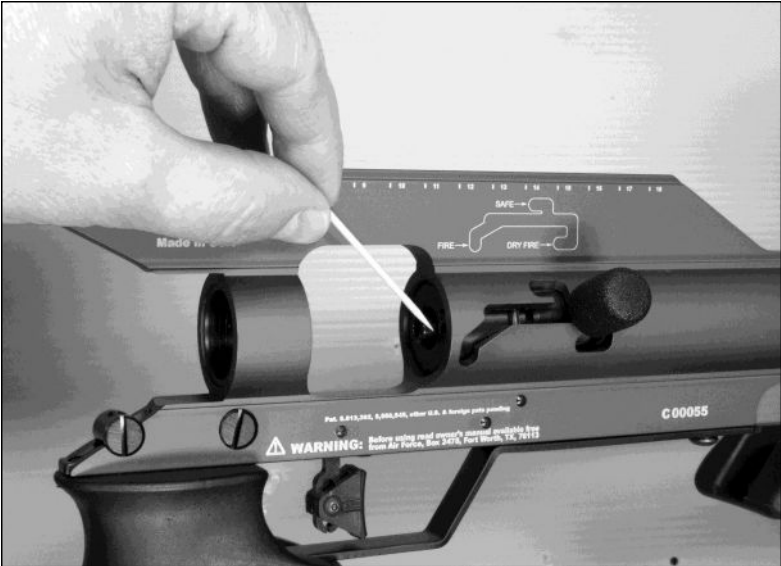

Figure 10.



Figure 11.

**AirForce Warranty
for Edge Air Rifles
Sold in the United States**

Mailing the enclosed warranty card within 60 days of purchase entitles the original buyer to a warranty covering defects in material and workmanship for one year.

Any AirForce Edge Air Rifle covered by this warranty will be repaired or replaced at the discretion of AirForce, should a defect in material or workmanship be found.

Repairs may only be made by the factory or an authorized service station. The warranty becomes invalid for any gun that is disassembled or modified in any way not specifically authorized by the factory. The warranty also becomes invalid for any gun that has been damaged by abuse or improper handling.

For shipping instructions for warranty service please call us at 1-877-247-4867.